

# **User's Manual**

**EPIA**

Version 1.21  
December 1, 2006

## **Copyright**

Copyright © 2003-2006 VIA Technologies Incorporated. All rights reserved.

No part of this document may be reproduced, transmitted, transcribed, stored in a retrieval system, or translated into any language, in any form or by any means, electronic, mechanical, magnetic, optical, chemical, manual or otherwise without the prior written permission of VIA Technologies, Incorporated.

## **Trademarks**

All trademarks are the property of their respective holders. PS/2 is a registered trademark of IBM Corporation. Award BIOS is a registered trademark of Phoenix Technologies Ltd.

## **Disclaimer**

No license is granted, implied or otherwise, under any patent or patent rights of VIA Technologies. VIA Technologies makes no warranties, implied or otherwise, in regard to this document and to the products described in this document. The information provided in this document is believed to be accurate and reliable as of the publication date of this document. However, VIA Technologies assumes no responsibility for the use or misuse of the information in this document and for any patent infringements that may arise from the use of this document. The information and product specifications within this document are subject to change at any time, without notice and without obligation to notify any person of such change.

## **FCC-B Radio Frequency Interference Statement**

This equipment has been tested and found to comply with the limits for a class B digital device, pursuant to part 15 of the FCC rules. These limits are designed to provide reasonable protection against harmful interference when the equipment is operated in a commercial environment. This equipment generates, uses and can radiate radio frequency energy and, if not installed and used in accordance with the instruction manual, may cause harmful interference to radio communications. Operation of this equipment in a residential area is likely to cause harmful interference, in which case the user will be required to correct the interference at his personal expense.

### **Notice 1**

The changes or modifications not expressly approved by the party responsible for compliance could void the user's authority to operate the equipment.

### **Notice 2**

Shielded interface cables and A.C. power cord, if any, must be used in order to comply with the emission limits.



Tested To Comply  
With FCC Standards  
FOR HOME OR OFFICE USE

## Safety Instructions

1. Always read the safety instructions carefully.
2. Keep this User's Manual for future reference.
3. Keep this equipment away from humidity.
4. Lay this equipment on a reliable flat surface before setting it up.
5. The openings on the enclosure are for air convection hence protects the equipment from overheating. DO NOT COVER THE OPENINGS.
6. Make sure the voltage of the power source and adjust properly 110/220V before connecting the equipment to the power inlet.
7. Place the power cord in such a way that people cannot step on it. Do not place anything over the power cord.
8. Always unplug the power cord before inserting any add-on card or module.
9. All cautions and warnings on the equipment should be noted.
10. Never pour any liquid into the opening. Liquid can cause damage or electrical shock.
11. If any of the following situations arises, get the equipment checked by a service personnel:
  - The power cord or plug is damaged
  - Liquid has penetrated into the equipment
  - The equipment has been exposed to moisture
  - The equipment has not work well or you cannot get it work according to User's Manual.
  - The equipment has dropped and damaged
  - If the equipment has obvious sign of breakage
12. DO NOT LEAVE THIS EQUIPMENT IN AN ENVIRONMENT UNCONDITIONED, STORAGE TEMPERATURE ABOVE 60 C (140F), IT MAY DAMAGE THE EQUIPMENT.

**CAUTION:** Explosion or serious damage may occur if the battery is incorrectly replaced. Replace only with the same or equivalent battery type recommended by the manufacturer.

---

## **Box CONTENTS**

---

- ☒ One VIA Mini-ITX mainboard
- ☒ One Quick Installation Guide
- ☒ One ATA-133/100 IDE ribbon cable
- ☒ One driver and utilities CD
- ☒ One IO bracket

---

## TABLE OF CONTENTS

---

Box Contents .....	i
Table of Contents .....	ii
Chapter 1 .....	1
Specifications .....	1
Mainboard Specifications .....	2
Mainboard Layout .....	4
Back Panel Layout .....	5
Back Panel Ports .....	6
Slots .....	6
Onboard Connectors .....	7
Onboard Jumpers .....	7
Chapter 2 .....	9
Installation .....	9
CPU .....	10
Memory Module Installation .....	13
Connecting the Power Supply .....	16
Back Panel Ports .....	18
Connectors .....	20
Jumpers .....	28
Slots .....	31
Chapter 3 .....	33
BIOS Setup .....	33
Entering Setup .....	34
Control Keys .....	35
Navigating the BIOS Menus .....	36
Getting Help .....	37
Main Menu .....	38
Standard CMOS Features .....	40
IDE Drives .....	42
Advanced BIOS Features .....	43
Advanced Chipset Features .....	48
DRAM Clock/Drive Control .....	50

---

AGP and P2P Bridge Control .....	51
CPU and PCI Bus Control.....	52
Integrated Peripherals.....	54
VIA OnChip IDE Device .....	56
VIA OnChip PCI Device .....	58
Super IO Device .....	60
Power Management Setup.....	62
Power Management .....	65
Wake Up Events .....	67
IRQs Activities .....	69
PNP/PCI Configurations.....	70
IRQ Resources .....	72
DMA Resources .....	73
PC Health Status.....	74
Load Defaults .....	75
Set Supervisor / User Password .....	76
Save & Exit Setup .....	78
Exit Without Saving .....	79
Chapter 4 .....	81
Driver Installation .....	81
Driver Utilities .....	82
CD Content .....	84

---

This page left intentionally blank.

---

# CHAPTER 1

## Specifications

The ultra-compact and highly integrated VIA EPIA uses the Mini-ITX mainboard form-factor developed by VIA Technologies, Inc. as part of the company's open industry-wide Total Connectivity initiative. The mainboard enables the creation of an exciting new generation of small, ergonomic, innovative and affordable embedded systems. Through a high level of integration, the Mini-ITX occupies 66% of the size of FlexATX mainboard form factor. The mainboard comes with an embedded VIA Processor, boasting of ultra-low power consumption, cool and quiet operation.

## **MAINBOARD SPECIFICATIONS**

---

### **CPU**

- VIA C3 / Eden EPGA Processor

### **Chipset**

- VIA VT8601A North Bridge
- VIA VT8231 South Bridge

### **Graphics**

- Integrated Trident Blade 3D graphics core

### **Audio**

- VIA VT1612A AC'97 Codec

### **Memory**

- 2 x PC100/133 DIMM slots

### **Expansion Slot**

- 1 x PCI slot

### **IDE**

- 2 x UltraDMA 33/66/100 connectors

### **LAN**

- VIA VT6103 10/100 Base-T Ethernet PHY

### **Back Panel I/O Ports**

- 1 x PS/2 mouse port and 1 x PS/2 keyboard port
- 1 x RJ-45 LAN port
- 1 x Serial port
- 1 x Parallel port
- 2 x USB 1.1 ports
- 1 x VGA port
- 3 x Audio Jacks: Line-out, Line-in and Mic-in

### **Onboard I/O Connectors**

- 1 x USB pin headers for 2 additional USB 1.1 ports
- 1 x Video-in pin header
- 1 x CD audio-in connector
- 1 x CIR pin header
- 1 x FIR pin header
- 2 x Fan connectors

### **BIOS**

- Award BIOS with 2Mbit flash memory capacity

### **Form Factor**

- Mini-ITX (4 layers)
- 17 cm X 17 cm

# MAINBOARD LAYOUT

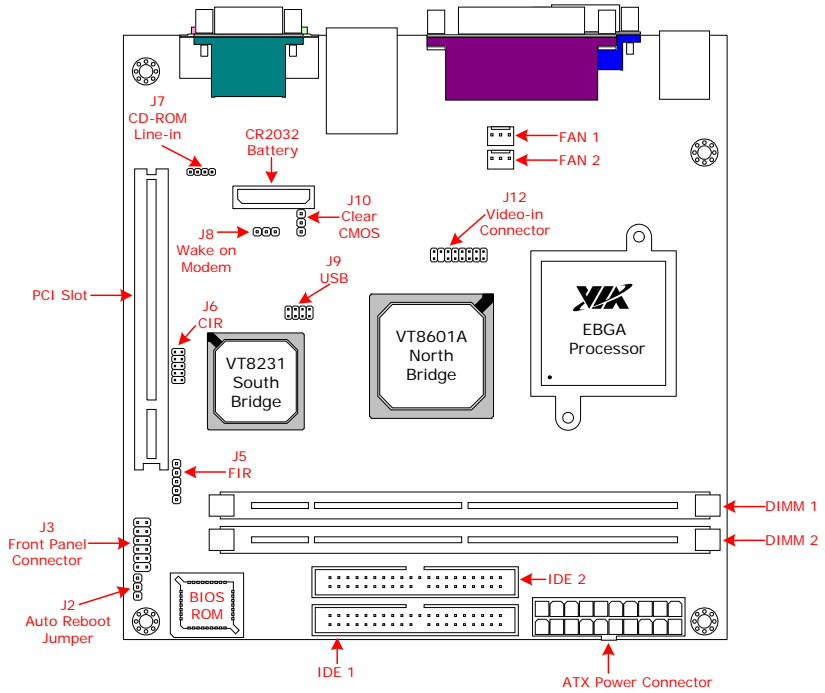

## BACK PANEL LAYOUT

---

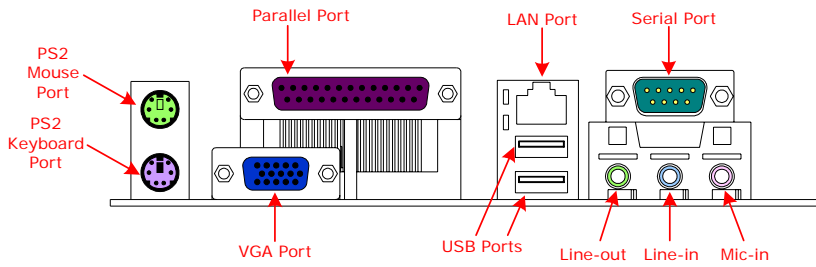

## BACK PANEL PORTS

---

Port	Description	Page
Audio ports	Line-out, Line-in and Mic-in	19
COM	Serial port	18
LPT	Parallel port	19
PS/2 Mouse	PS/2 mouse port	18
PS/2 Keyboard	PS/2 keyboard port	18
RJ45	RJ45 port	19
USB	USB 1.1 ports	19
VGA	VGA port	18

## SLOTS

---

Port	Description	Page
DDR DIMM	Memory module slot	13
PCI	Expansion card slot	31

---

## ONBOARD CONNECTORS

---

<b>Connector</b>	<b>Description</b>	<b>Page</b>
ATXPWR	Power cable connector	16
FAN1-2	CPU fan connector	12
IDE 1-2	IDE drive connectors	20
J3	Front panel connector	21
J5	FIR connector	22
J6	CIR connector	23
J7	Onboard CD audio cable connector	25
J8	Wake-on Modem	27
J9	Universal Serial Bus 1.1 connector	24
J12	VIP connector	26

---

## ONBOARD JUMPERS

---

<b>Jumper</b>	<b>Description</b>	<b>Page</b>
J2	Auto Reboot Function	30
J10	Reset CMOS settings	29

This page left intentionally blank.

---

# CHAPTER 2

## Installation

This chapter provides you with information about hardware installation procedures. It is recommended to use a grounded wrist strap before handling computer components. Electrostatic discharge (ESD) can damage some components.

## CPU

---

### The VIA C3 E-Series Processor

The VIA EPIA Mini-ITX mainboard includes an embedded VIA C3 or Eden Processor. The VIA C3 Processor provides ultra-low power consumption and advanced thermal dissipation properties. The VIA C3 Processor requires heatsink and a CPU fan to provide sufficient cooling. Ensure that the CPU fan is correctly installed as shown.

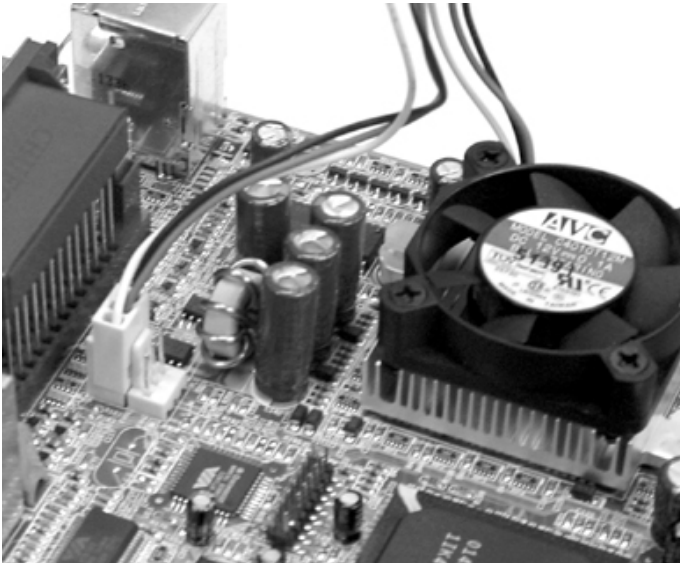

## The VIA Eden Processor

Providing ultra-low power consumption and advanced thermal dissipation properties, the VIA Eden Processor features a fanless design. The VIA Eden Processor requires only a heatsink as shown.

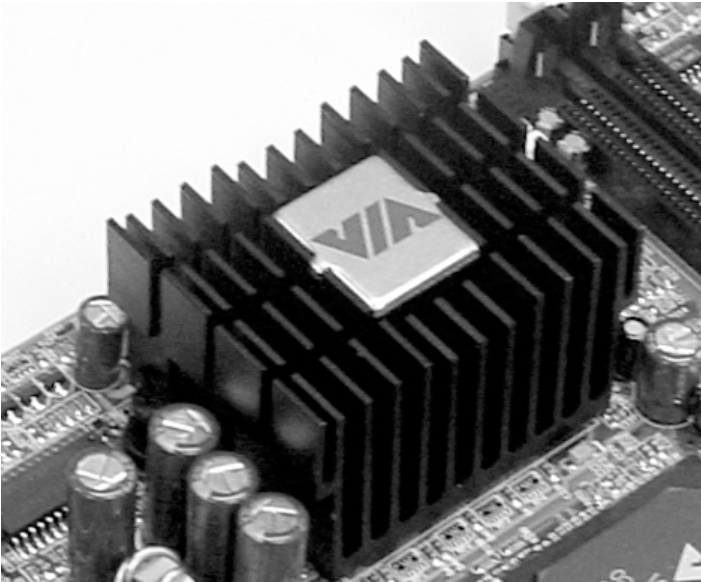

**WARNING:** This mainboard is not designed to support overclocking. Any attempt to operate beyond product specifications is not recommended. *We do not guarantee against damages or risks caused by inadequate operation or beyond product specifications.*

### CPU Fan and System Fan: CPUFAN and SYSFAN

The CPUFAN (CPU fan) and SYSFAN (system fan) run on +12V and maintain system cooling. When connecting the wire to the connectors, always be aware that the red wire is the Positive and should be connected to the +12V. The black wire is Ground and should always be connected to GND. The CPU system and power fan connectors have sensors to support fan monitoring.

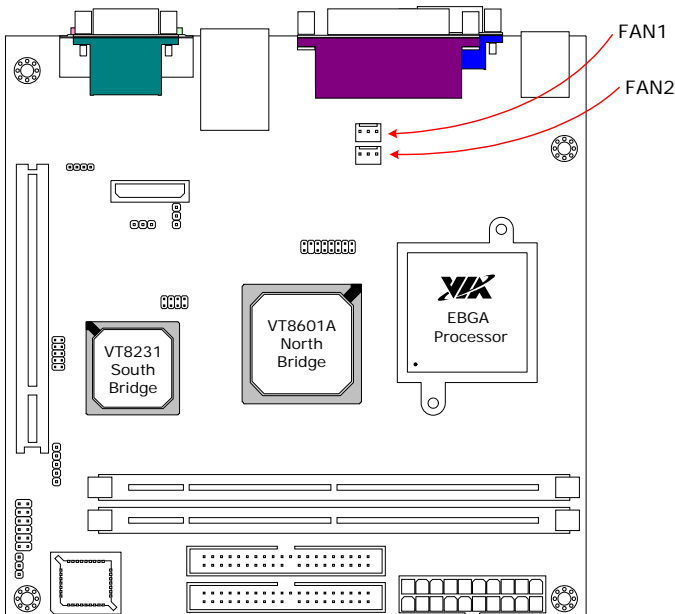

## MEMORY MODULE INSTALLATION

The VIA EPIA Mini-ITX mainboard provides one 168-pin DIMM slot for PC100/133 SDRAM memory modules and supports memory sizes up to 512MB per slot.

### DDR SDRAM Module Installation Procedures

- Locate the DIMM sockets in the motherboard.

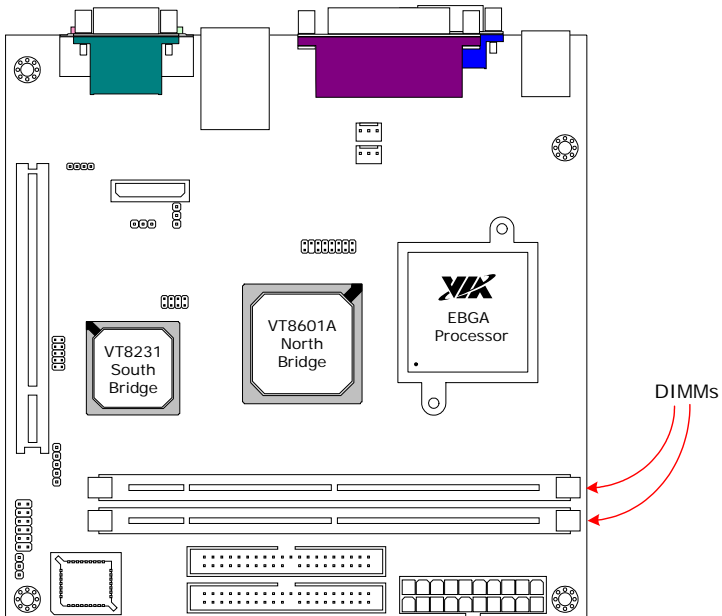

- Unlock a DIMM socket by pressing the retaining clips outward.
- Align a DIMM on the socket such that the notch on the DIMM matches the break on the socket.

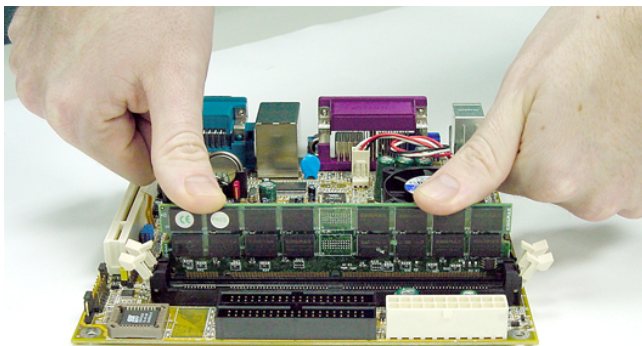

- Firmly insert the DIMM into the socket until the retaining clips snap back in place and the DIMM is properly seated.

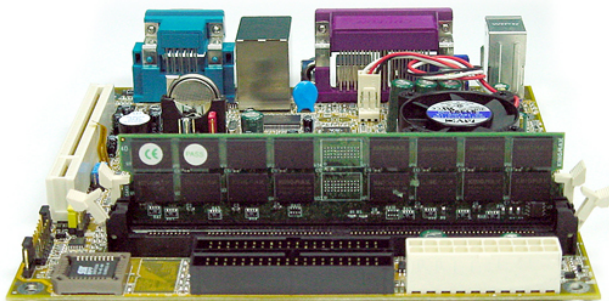

## Available DDR SDRAM Configurations

Refer to the table below for available DDR SDRAM configurations on the mainboard.

<b>Slot</b>	<b>Module Size</b>	<b>Total</b>
DIMM 1	32MB, 64MB, 128MB, 256MB, 512MB	32MB-512MB
DIMM 2	32MB, 64MB, 128MB, 256MB, 512MB	32MB-512MB
Maximum supported system memory		1GB

## CONNECTING THE POWER SUPPLY

The VIA EPIA Mini-ITX mainboard supports a conventional ATX power supply for the power system. Before inserting the power supply connector, always make sure that all components are installed correctly to ensure that no damage will be caused.

### ATX 20-Pin Power Connector

To connect the ATX power supply, make sure the power plug is inserted in the proper orientation and the pins are aligned. Then push down the plug firmly into the connector.

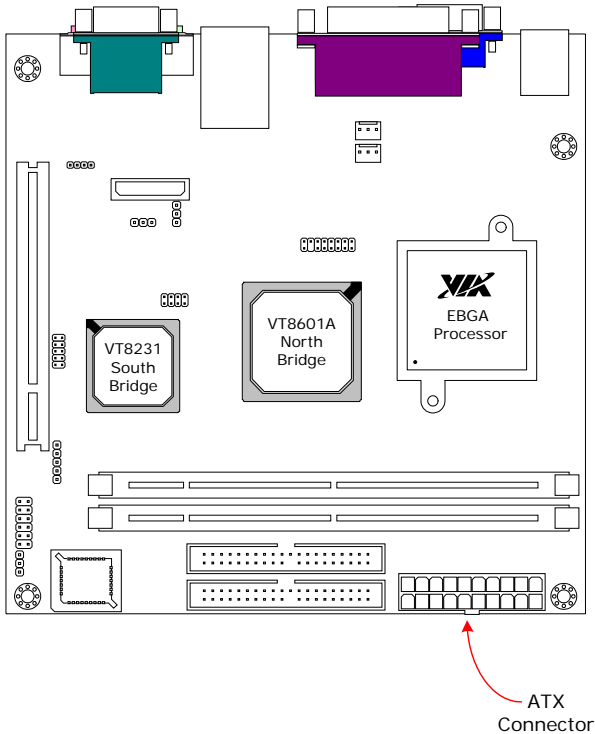

**ATX 20 Pin Power Connector**

---

<b>Pin</b>	<b>Signal</b>	<b>Pin</b>	<b>Signal</b>
1	+3.3V	11	+3.3V
2	+3.3V	12	-12V
3	GND	13	GND
4	+5V	14	Power Supply On
5	GND	15	GND
6	+5V	16	GND
7	GND	17	GND
8	Power Good	18	NC
9	+5V Standby	19	+5V
10	+12V	20	+5V

## BACK PANEL PORTS

---

The back panel has the following ports:

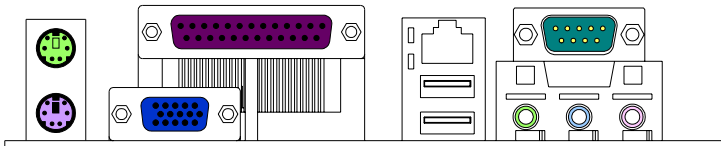

### Keyboard and Mouse

The green 6-pin connector is for a PS/2 mouse. The purple connector is for a PS/2 keyboard.

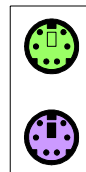

### VGA Out

The 15-pin female VGA connector can be used to connect to any analog VGA monitor.

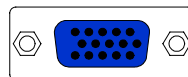

### Serial port: COM 1

This 9-pin COM 1 port is for pointing devices or other serial devices.

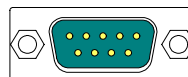

---

## RJ45 10/100 LAN Connector

The mainboard provides a standard RJ-45 port. This port allows connection to a Local Area Network (LAN) through a network hub

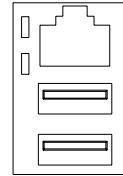

## USB 1.1 ports 1 and 2

These two 4-pin Universal Serial Bus (USB) ports are available for connecting USB 1.1 devices.

## LPT port

The 25-pin female parallel port for connecting printers supports Enhanced Parallel Port and Extended Capabilities Port modes.

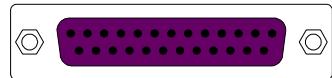

## Audio Port:



## Line Out jack

This Line Out (lime) jack connects a headphone or a speaker.

## Line In jack

This Line In (light blue) jack connects a tape player or other audio devices.

## Microphone jack

This Mic (pink) jack connects a microphone.

## CONNECTORS

### Hard Disk Connectors: IDE1 & IDE2

The two IDE connectors support Ultra DMA 33/66/100 modes. Both IDE connectors can connect a master and a slave drive. The IDE connectors can support up to four IDE devices.

If two drives are connected to a single cable, the jumper on the second drive must be set to slave mode. Refer to the drive documentation supplied by the vendor for the jumper settings.

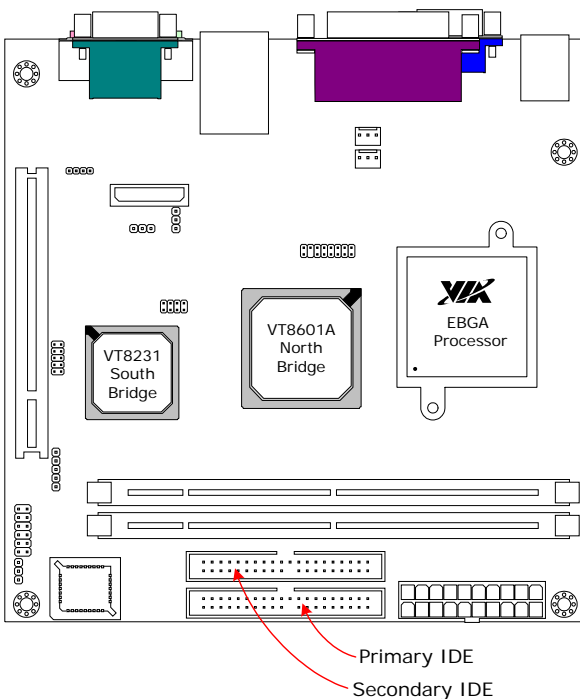

### Front Panel Connectors: J3

The J3 pin header allows you to connect the power switch, reset switch, power LED, HDD LED and the case speaker.

Pin	Signal	Pin	Signal
1	HDD LED+	2	Power LED+
3	HDD LED-	4	N/A
5	Power Switch	6	Power LED-
7	Power Switch	8	N/A
9	Reset Switch	10	N/A
11	Reset Switch	12	N/A

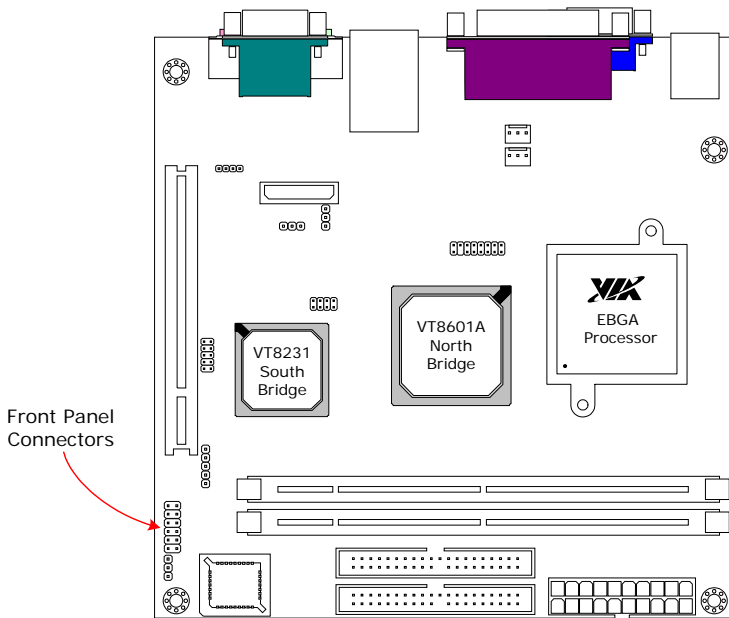

## FIR Module Connector: J5

This pin header is used to connect to a Fast IrDA module. The BIOS settings must be configured to activate the IR function.

Pin	Signal	Description
1	+3V	VCC
2	IRRX	FIR/SIR Data Receive
3	IRRX2	SIR Data Receive
4	GND	Ground
5	IRTX	FIR/SIR Data Transmit

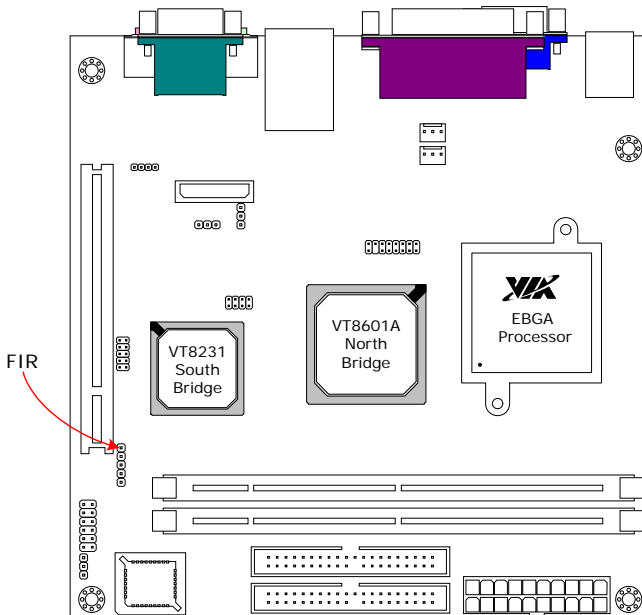

## CIR Module Connector: J6

This pin header is used to connect to a Consumer IrDA module.

Pin	Signal	Pin	Signal
1	+5V	2	GND
3	KB_CLK	4	KB_DATA
5	EKBCLK	6	EKBDATA
7	MS_CLK	8	MS_DATA
9	EMCLK	10	EMDATA

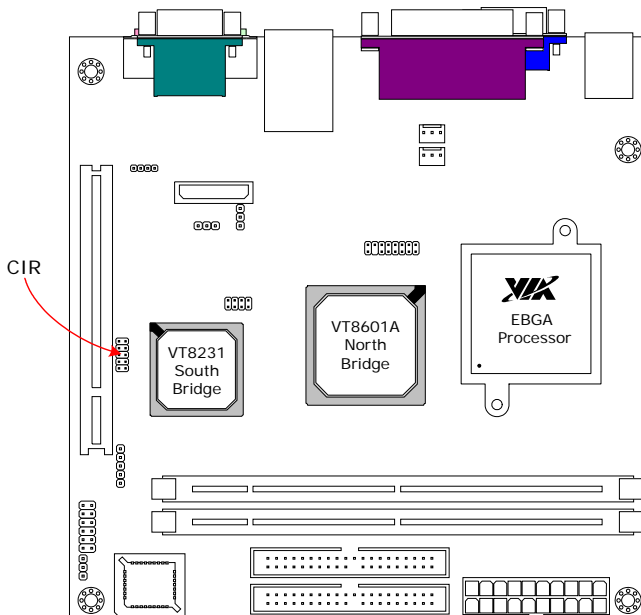

### USB Pin Connector: J9

The mainboard provides 1 front USB pin header connectors, allowing up to 2 additional USB 1.1 ports. Connect each 2-port USB cable into each pin headers. These ports can be used to connect USB interface peripherals such as USB HDD, digital cameras, MP3 players, printers, modem, etc.

Pin	Signal	Pin	Signal
1	+5V	2	GND
3	USB P2-	4	USB P2+
5	USB P3-	6	USB P3+
7	-OC2	8	-OC3

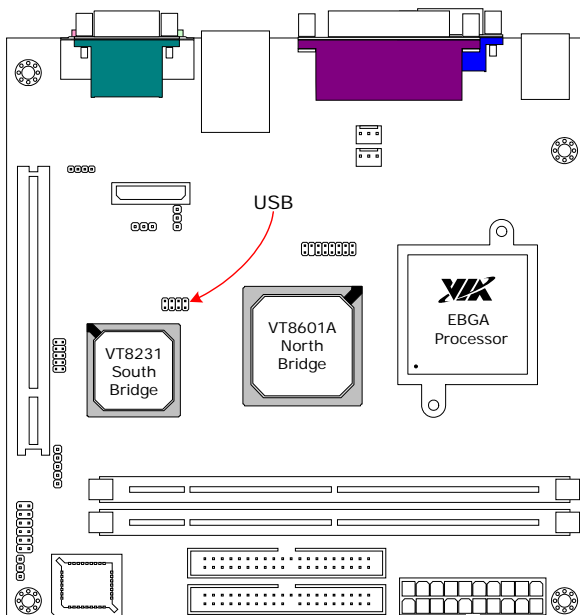

## CD Audio Connector: J7

This connector allows you to receive stereo audio input from sound source such as a CD-ROM.

Pin	Signal
1	Left channel
2	GND
3	GND
4	Right channel

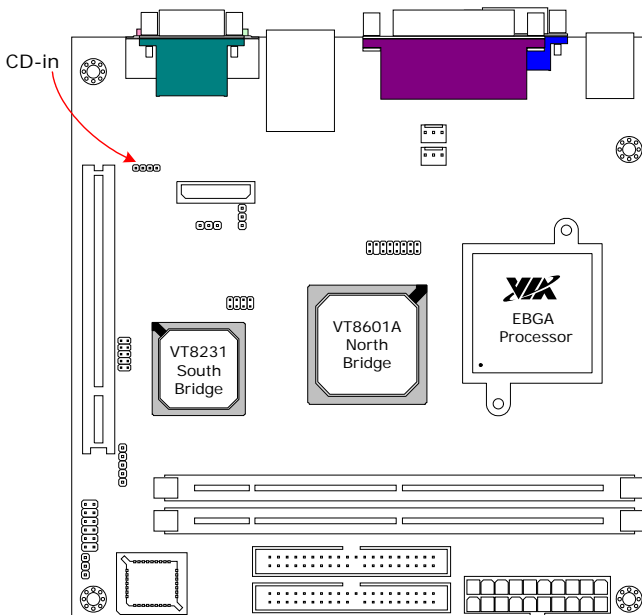

### Video-in Connector (Pins 1-12): J12

The Video-in connector (pins 1-12) allows you to connect from an external video source. The PCI riser card connector (pins 13-16) allows you to connect a PCI riser card module.

Pin	Signal	Pin	Signal
1	GND	2	CVD0
3	CVD7	4	CVD4
5	CVD6	6	CVD5
7	CVHS	8	CVD2
9	CVD1	10	CVD3
11	CVVS	12	CVCLK
13	A_D30	14	N/A
15	-GNT2	16	-REQ2

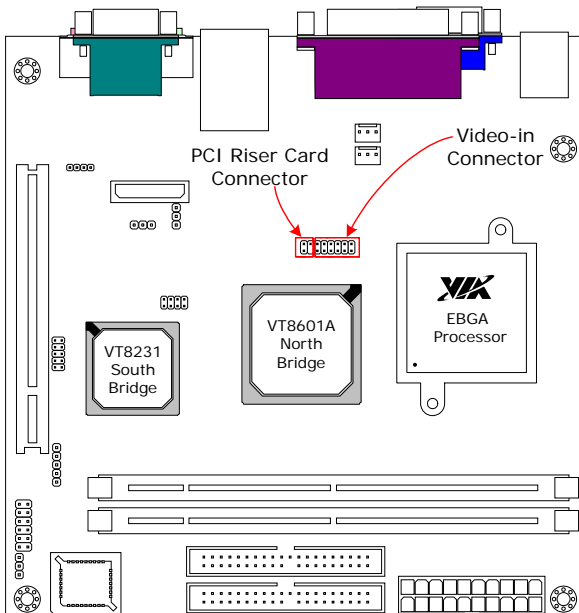

## Wake-on Modem: J8

The Wake-on Modem connector enables a modem with the Wake-on Modem feature to power up the system when a ring-in signal is received through the modem.

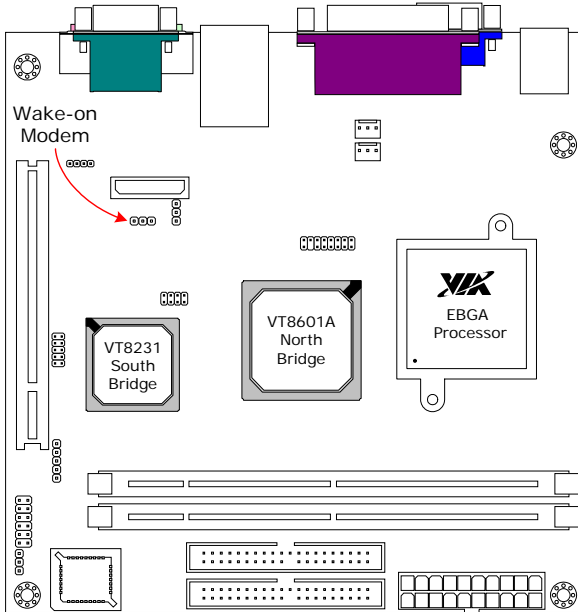

## JUMPERS

The mainboard provides jumpers for setting some mainboard functions. This section will explain how to change the settings of the mainboard functions using the jumpers.

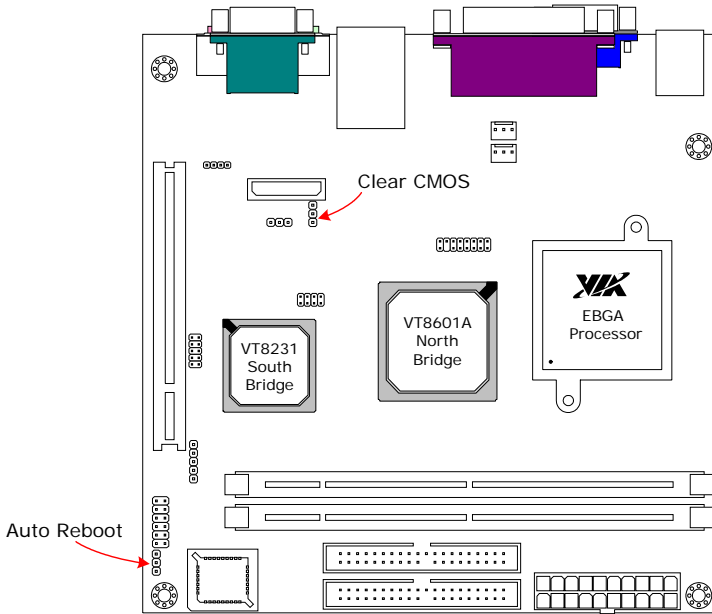

## Clear CMOS: J10

This jumper allows you to clear the Real Time Clock (RTC) RAM in CMOS. You can clear the CMOS memory of date, time and system setup parameters by erasing the CMOS RTC RAM data. The onboard button cell battery powers the RAM data in CMOS that include system setup information such as system passwords.

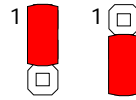

1-2: Normal (Default)  
2-3: Clear CMOS

To erase the RTC RAM:

1. Turn OFF the computer and unplug the power cord.
2. Remove the onboard battery
3. Move the jumper cap from pins 1-2 (default) to pins 2-3. Keep cap on pins 2-3 for about 5~10 seconds, then move the cap back to pins 1-2.
4. Replace the battery.
5. Plug the power cord and turn ON the computer.
6. Hold down the <Del> key during the boot process and enter BIOS setup to re-enter data.

**WARNING:** Except when clearing the RTC RAM, never remove the cap on CLEAR\_CMOS jumper default position. Removing the cap will cause system boot failure. Avoid clearing the CMOS while the system is on; it will damage the mainboard.

### **Auto Reboot Function Setting: J2**

This jumper enables or disables the Auto Reboot function. When enabled, the system will automatically reboot in the event of a sudden power interruption.

---

## SLOTS

---

### Peripheral Component Interconnect: PCI

The PCI slot allows you to insert PCI expansion card. When adding or removing expansion card, first unplug the power supply. Read the documentation for the expansion card if any changes to the system are necessary.

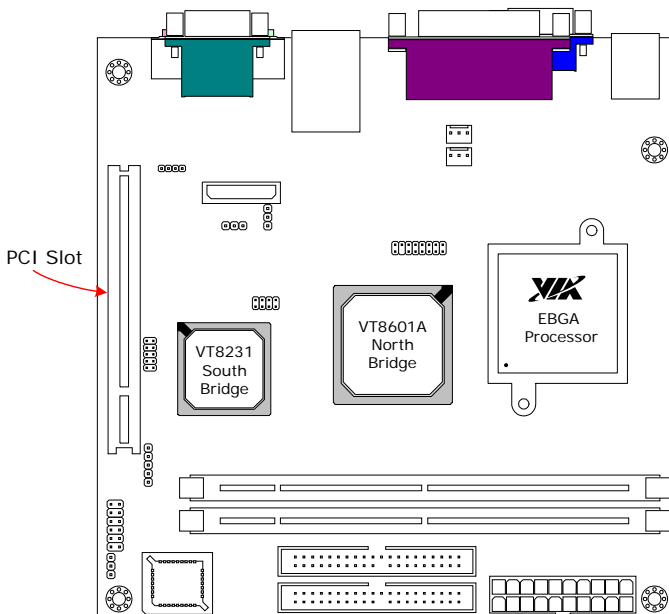

### PCI Interrupt Request Routing

The IRQ (interrupt request line) are hardware lines over which devices can send interrupt signals to the microprocessor. The "PCI & LAN" IRQ pins are typically connected to the PCI bus INT A# ~ INT D# pins as follows:

	<b>Order 1</b>	<b>Order 2</b>	<b>Order 3</b>	<b>Order 4</b>
PCI Slot 1	INT B#	INT C#	INT D#	INT A#
LAN	INT B#			

---

# CHAPTER 3

## BIOS Setup

This chapter gives a detailed explanation of the BIOS setup functions.

## **ENTERING SETUP**

---

Power on the computer and press <Delete> during the beginning of the boot sequence to enter the BIOS setup menu. If you missed the BIOS setup entry point, you may restart the system and try again.

---

## CONTROL KEYS

---

<b>Keys</b>	<b>Description</b>
Up Arrow	Move to the previous item
Down Arrow	Move to the next item
Left Arrow	Move to the item in the left side
Right Arrow	Move to the item in the right side
Enter	Select the item
Escape	Jumps to the Exit menu or returns to the main menu from a submenu
Page Up / +	Increase the numeric value or make changes
Page Down / -	Decrease the numeric value or make changes
F1	General help, only for Status Page Setup Menu and Option Page Setup Menu
F5	Restore the previous CMOS value from CMOS, only for Option Page Setup Menu
F6	Load the default CMOS value from Fail-Safe default table, only for Option Page Setup Menu
F7	Load Optimized defaults
F9	Jumps to the Main Menu
F10	Save all the CMOS changes and exit

## **NAVIGATING THE BIOS MENUS**

---

The main menu displays all the BIOS setup categories. Use the control keys Up/Down arrow keys to select any item/sub-menu. Description of the selected/highlighted category is displayed at the bottom of the screen.

An arrow symbol next to a field indicates that a sub-menu is available (see figure below). Press <Enter> to display the sub-menu. To exit the sub-menu, press <Esc>.

## **GETTING HELP**

---

The BIOS setup program provides a "General Help" screen. You can display this screen from any menu/sub-menu by pressing <F1>. The help screen displays the keys for using and navigating the BIOS setup. Press <Esc> to exit the help screen.

## MAIN MENU

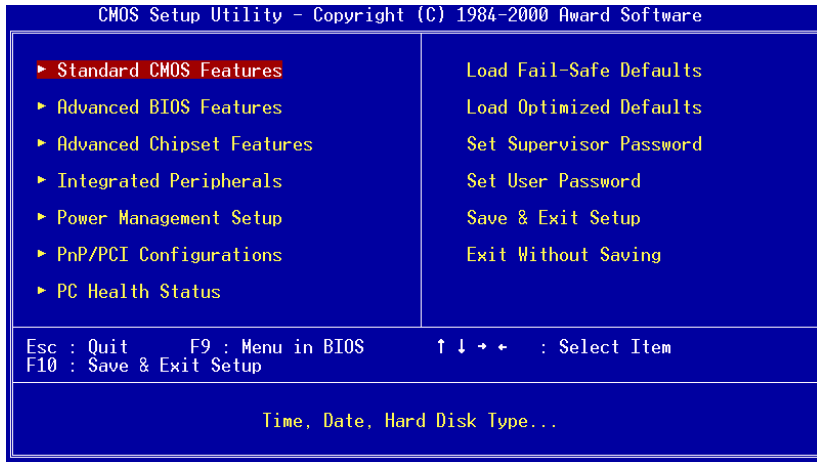

### Standard CMOS Features

Use this menu to set basic system configurations.

### Advanced BIOS Features

Use this menu to set the advanced features available on your system.

### Advanced Chipset Features

Use this menu to set chipset specific features and optimize system performance.

### Integrated Peripherals

Use this menu to set onboard peripherals features.

### Power Management Setup

Use this menu to set onboard power management functions.

### PnP/PCI Configurations

Use this menu to set the PnP and PCI configurations.

**PC Health Status**

This menu shows the PC health status.

**Load Fail-Safe Defaults**

Use this menu option to load the BIOS default settings for minimal and stable system operations.

**Load Optimized Defaults**

Use this menu option to load BIOS default settings for optimal and high performance system operations.

**Set Supervisor Password**

Use this menu option to set the BIOS supervisor password.

**Set User Password**

Use this menu option to set the BIOS user password.

**Save & Exit Setup**

Save BIOS setting changes and exit setup.

**Exit Without Saving**

Discard all BIOS setting changes and exit setup.

## STANDARD CMOS FEATURES

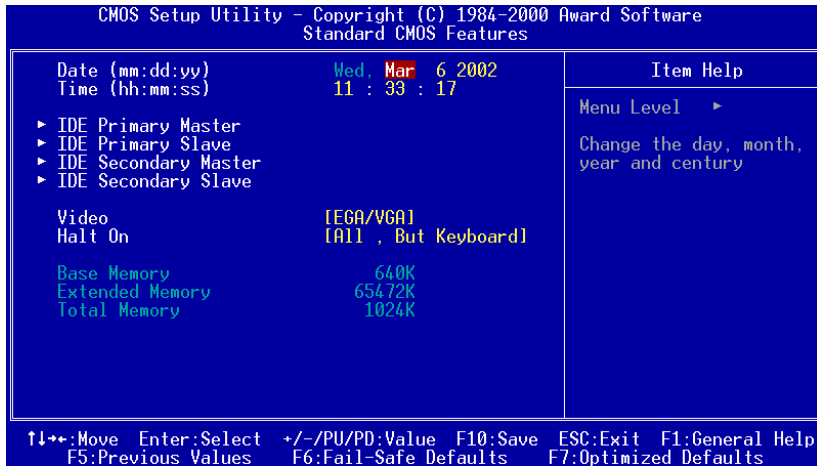

### Date

The date format is [Day, Month Date Year]

### Time

The time format is [Hour : Minute : Second]

### Video

Set the video mode.

Settings: [EVGA/VGA, CGA 40, CGA 80, Mono]

## Halt On

Sets the system's response to specific boot errors. Below is a table that details the possible settings.

<b>Setting</b>	<b>Description</b>
All Errors	System halts when any error is detected
No Errors	System does not halt for any error
All but Keyboard	System halts for all non-key errors
All but Diskette	System halts for all non-diskette errors
All but Disk/Key	System halts for all errors (except diskette or keyboard errors)

## IDE DRIVES

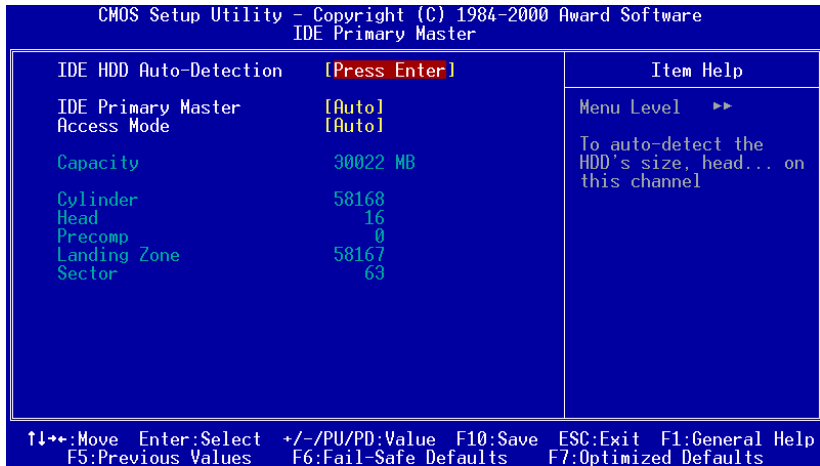

The specifications of your drive must match with the drive table. The hard disk will not work properly if you enter incorrect information in this category. Select “Auto” whenever possible. If you select “Manual”, make sure the information is from your hard disk vendor or system manufacturer. Below is a table that details required hard drive information when using the “Manual” mode.

Setting	Description
IDE Channel	The name of this item will match the name of the menu (e.g. IDE Primary Master). Settings: [None, Auto, Manual]
Access Mode	Settings: [CHS, LBA, Large, Auto]
Capacity	Formatted size of the storage device
Cylinder	Number of cylinders
Head	Number of heads
Precomp	Write precompensation
Landing Zone	Cylinder location of the landing zone
Sector	Number of sectors
PIO Mode	Settings: [0, 1, 2, 3, 4]

## ADVANCED BIOS FEATURES

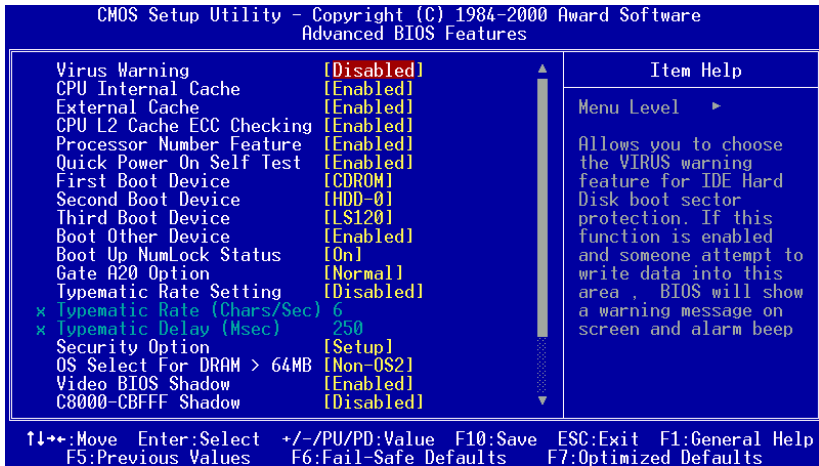

### Virus Warning

Setting	Description
Enabled	Turns on hard disk boot sector virus protection
Disabled	Turns off hard disk boot sector virus protection

### CPU Internal Cache

Setting	Description
Enabled	Turns on CPU internal cache
Disabled	Turns off CPU internal cache

### External Cache

Setting	Description
Enabled	Enables the CPU L2 cache
Disabled	Disables the CPU L2 cache

## CPU L2 Cachw ECC Checking

Setting	Description
Enabled	Enables ECC for L2 cache
Disabled	Disables ECC for L2 cache

## Quick Power On Self-Test

Shortens Power On Self-Test (POST) cycle to enable shorter boot up time.

Setting	Description
Enabled	Shorten Power On Self Test (POST) cycle and bootup time
Disabled	Standard Power On Self Test (POST)

## First/Second/Third Boot Device

Set the boot device sequence as BIOS attempts to load the disk operating system.

Setting	Description
LS120	Boot from LS-120 drive
HDD-0	Boot from the first HDD
SCSI	Boot from SCSI
CD-ROM	Boot from CD-ROM
HDD-1	Boot from the second HDD
HDD-2	Boot from the third HDD
HDD-3	Boot from the fourth HDD
ZIP100	Boot from ATAPI ZIP drive
USB-FDD	Boot from USB floppy drive
USB-ZIP	Boot from USB ZIP drive
USB-CDROM	Boot from USB CDROM
LAN	Boot from network drive
Disabled	Disable the boot device sequence

## Boot Other Device

Enables the system to boot from alternate devices if the system fails to boot from the "First/Second/Third Boot Device" list.

Setting	Description
Enabled	Enable alternate boot device
Disabled	No alternate boot device allowed

## Boot Up NumLock Status

Set the NumLock status when the system is powered on.

Setting	Description
On	Forces keypad to behave as 10-key
Off	Forces keypad to behave as arrow keys

## Gate A20 Option

Sets the Gate A20 option.

Settings: [Normal, Fast]

## Typematic Rate Setting

Enables "Typematic Rate" and "Typematic Delay" functions.

Settings: [Enabled, Disabled]

## Typematic Rate (Chars/Sec)

This item sets the rate (characters/second) at which the system retrieves a signal from a depressed key.

Settings: [6, 8, 10, 12, 15, 20, 24, 30]

## Typematic Delay (Msec)

This item sets the delay between when the key was first pressed and when the system begins to repeat the signal from the depressed key.

Settings: [250, 500, 750, 1000]

### Security Option

Selects whether the password is required every time the System boots, or only when you enter Setup.

Setting	Description
Setup	Password prompt appears only when end users try to run BIOS Setup
System	Password prompt appears every time when the computer is powered on and when end users try to run BIOS Setup

### OS Select for DRAM > 64MB

Select the OS type used.

Settings: [Non-OS2, OS2]

### Video BIOS Shadow

Enable shadow for the Video BIOS.

Settings: [Enabled, Disabled]

### C8000-CBFFF Shadow

Enable shadow in the C8000-CBFFF region.

Settings: [Enabled, Disabled]

### CC000-CFFFF Shadow

Enable shadow in the C8000-CFFFF region.

Settings: [Enabled, Disabled]

### D0000-D3FFF Shadow

Enable shadow in the D0000-D3FFF region.

Settings: [Enabled, Disabled]

### D4000-D7FFF Shadow

Enable shadow in the D4000-D7FFF region.

Settings: [Enabled, Disabled]

### **D8000-DBFFF Shadow**

Enable shadow in the D8000-DBFFF region.

Settings: [Enabled, Disabled]

### **DC000-DFFFF Shadow**

Enable shadow in the DC000-DFFFF region.

Settings: [Enabled, Disabled]

## ADVANCED CHIPSET FEATURES

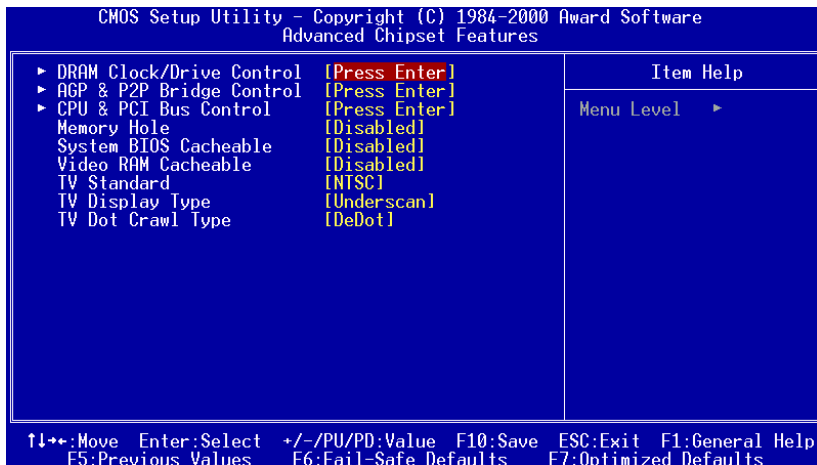

**WARNING:** The Advanced Chipset Features menu is used for optimizing the chipset functions. Do not change these settings unless you are familiar with the chipset.

### Memory Hole

Select whether to have a memory hole at 15M to 16M area.

Settings: [Disabled, 15M-16M]

### System BIOS Cacheable

Cache the System BIOS.

Settings: [Disabled, Enabled]

### Video RAM Cacheable

Cache the Video RAM.

Settings: [Disabled, Enabled]

### **TV Standard**

Set the TV Standard of the TV output.

Settings: [NTSC, PAL]

### **TV Display Type**

Set the TV display type.

Settings: [Underscan, Overscan]

### **TV Dot Crawl Type**

Set the TV Dot Crawl Type.

Settings: [DeDot, Dot]

## DRAM CLOCK/DRIVE CONTROL

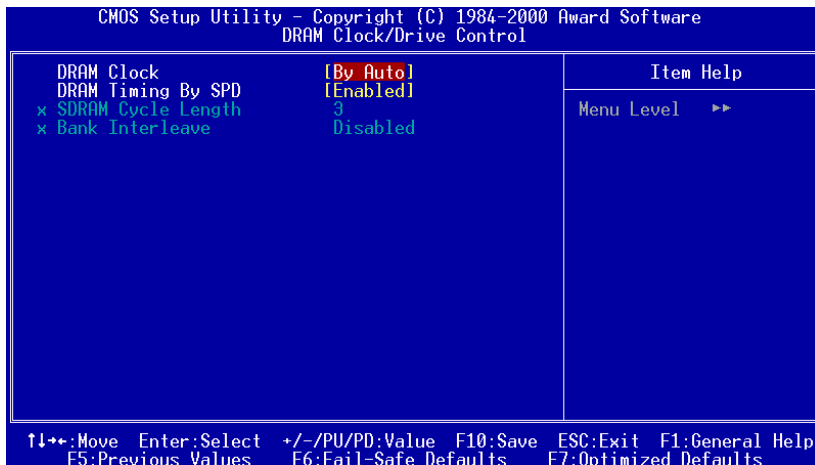

### DRAM Clock

Set the DRAM Clock.

Settings: [Host CLK, HCLK-33M, By Auto]

### DRAM Timing By SPD

Set the DRAM Timing by SPD.

Settings: [Disabled, Enabled]

### SDRAM Cycle Length

Set the DRAM Cycle Length.

Settings: [3, 2]

### Bank Interleave

Set the Bank Interleave mode.

Settings: [Disabled, 2 Bank, 4 Bank]

## AGP AND P2P BRIDGE CONTROL

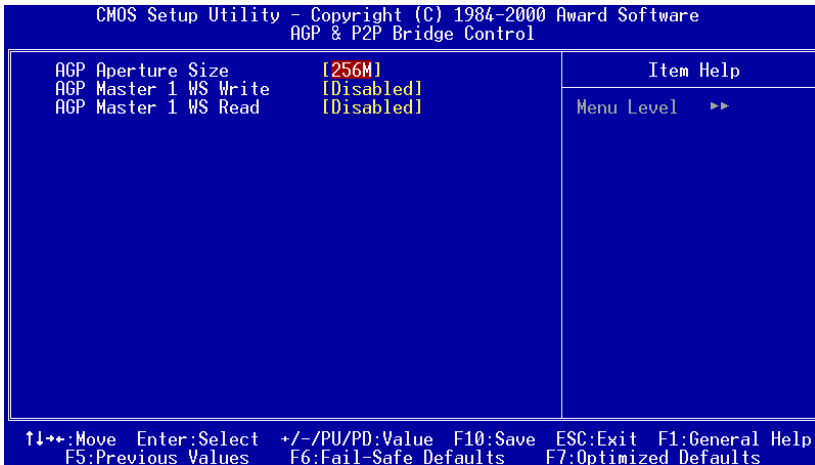

### AGP Aperture Size

Set the AGP Aperture Size.

Settings: [256M, 128M, 64M, 32M, 16M, 8M, 4M]

### AGP Master 1 WS Write

Set the AGP Master 1 WS Write.

Settings: [Disabled, Enabled]

### AGP Master 1 WS Read

Set the AGP Master 1 WS Read.

Settings: [Disabled, Enabled]

## CPU AND PCI BUS CONTROL

CMOS Setup Utility - Copyright (C) 1984-2000 Award Software CPU & PCI Bus Control	
P2C/C2P Concurrency	[Enabled]
Fast R-W Turn Around	[Disabled]
CPU to PCI Write Buffer	[Enabled]
PCI Dynamic Bursting	[Enabled]
PCI Master 0 WS Write	[Enabled]
PCI Delay Transaction	[Disabled]
PCI#2 Access #1 Retry	[Disabled]
	Item Help
	Menu Level ▶▶
↑↓←→:Move Enter:Select +/-/PU/PD:Value F10:Save ESC:Exit F1:General Help F5:Previous Values F6:Fail-Safe Defaults F7:Optimized Defaults	

### P2C/C2P Concurrency

Set the P2C/C2P Concurrency.

Settings: [Disabled, Enabled]

### Fast R-W Turn Around

Set the Fast R-W Turn Around.

Settings: [Disabled, Enabled]

### CPU to PCI Write Buffer

Set the CPU to PCI Write Buffer.

Settings: [Disabled, Enabled]

### PCI Dynamic Bursting

Set the PCI Dynamic Bursting.

Settings: [Disabled, Enabled]

**PCI Master 0 WS Write**

Set the PCI Master 0 WS Write.

Settings: [Disabled, Enabled]

**PCI Delay Transaction**

Set the PCI Delay Transaction.

Settings: [Disabled, Enabled]

**PCI #2 Access #1 Retry**

Set the PCI #2 Access #1 Retry.

Settings: [Disabled, Enabled]

## INTEGRATED PERIPHERALS

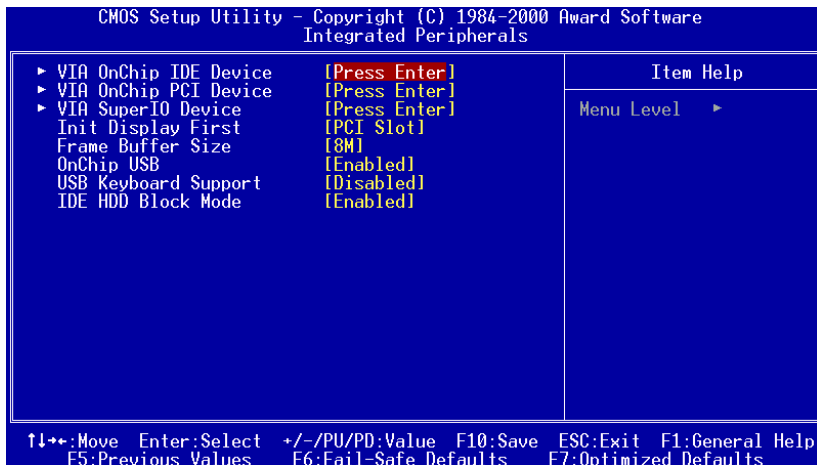

### Init Display First

This setting specifies which VGA card is your primary graphics adapter.

Settings: [PCI Slot, AGP]

### Frame Buffer Size

This setting specifies the frame buffer size.

Settings: [2M, 4M, 8M]

### OnChip USB

Set the state of the OnChip USB.

Settings: [Disabled, Enabled]

### USB Keyboard Support

This setting specifies whether the BIOS will support USB keyboards.

Settings: [Disabled, Enabled]

### **IDE HDD Block Mode**

This setting specifies if the IDE hard drive supports block mode.

Settings: [Disabled, Enabled]

## VIA ONCHIP IDE DEVICE

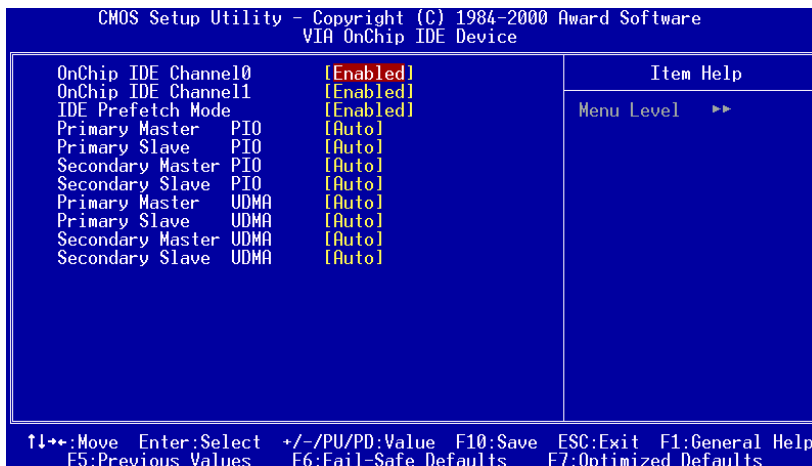

### Onboard IDE Channel 0 and 1

The integrated peripheral controller contains an IDE interface with support for two IDE channels.

Setting	Description
Enabled	Activates each channel separately
Disabled	Deactivates IDE channels

### IDE Prefetch Mode

This allows the hard disk controller to use the fast block mode to transfer data to and from the hard disk drive. Block mode is also called block transfer, multiple commands or multiple sector read / write.

Setting	Description
Enabled	Block mode
Disabled	Standard mode

**Primary Master/Slave PIO**

These settings specify the PIO mode for the Primary Master/Slave IDE devices.

Settings: [Auto, Mode 0, Mode 1, Mode 2, Mode 3, Mode 4]

**Secondary Master/Slave PIO**

These settings specify the PIO mode for the Secondary Master/Slave IDE devices.

Settings: [Auto, Mode 0, Mode 1, Mode 2, Mode 3, Mode 4]

**Primary Master/Slave UDMA**

These settings specify the UDMA mode for the Primary Master/Slave IDE devices.

Settings: [Disabled, Auto]

**Secondary Master/Slave UDMA**

These settings specify the UDMA mode for the Secondary Master/Slave IDE devices.

Settings: [Disabled, Auto]

## VIA ONCHIP PCI DEVICE

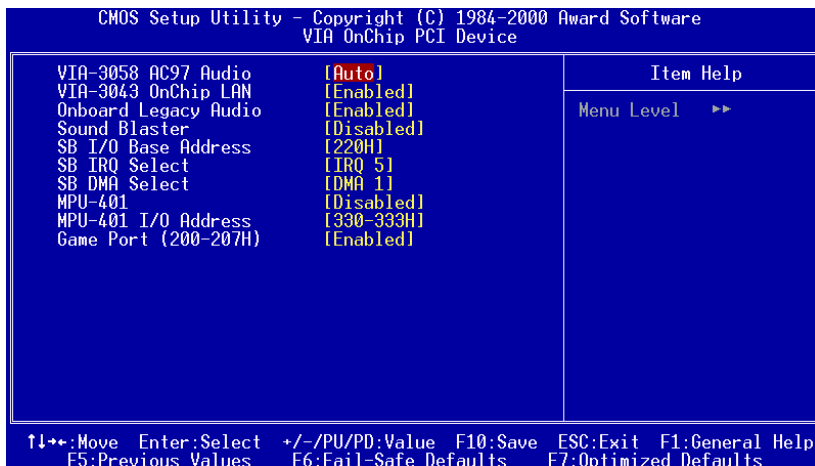

### AC'97 Audio

Auto allows the mainboard to VIA detect whether an audio device is used. If the device is detected, the onboard VIA AC'97 (Audio Codec'97) controller will be enabled; otherwise, it is disabled. Disable the controller if another controller card is being used to connect to an audio device.

Setting	Description
Auto	Enables onboard controller if audio device is detected
Disabled	Turn off onboard controller to allow external controller

### VIA OnChip LAN

Settings: [Enabled, Disabled]

### OnBoard Legacy Audio

Settings: [Enabled, Disabled]

**Sound Blaster**

Settings: [Enabled, Disabled]

**SB I/O Base Address**

Set the Sound Blaster I/O base address.

Settings: [220H, 240H, 260H, 280H]

**SB IRQ Select**

Set the Sound Blaster IRQ.

Settings: [IRQ5, IRQ7, IRQ9, IRQ10]

**SB DMA Select**

Set the Sound Blaster DMA channel.

Settings: [DMA 0, DMA 1, DMA 2, DMA 3]

**MPU-401**

Settings: [Enabled, Disabled]

**MPU-401 I/O Address**

Set the MPU-401 I/O address

Settings: [300-303H, 310-313H, 320-33H, 330-333H]

**Game Port (200-207H)**

Set the game port at address (200-207H).

Settings: [Enabled, Disabled]

## SUPER IO DEVICE

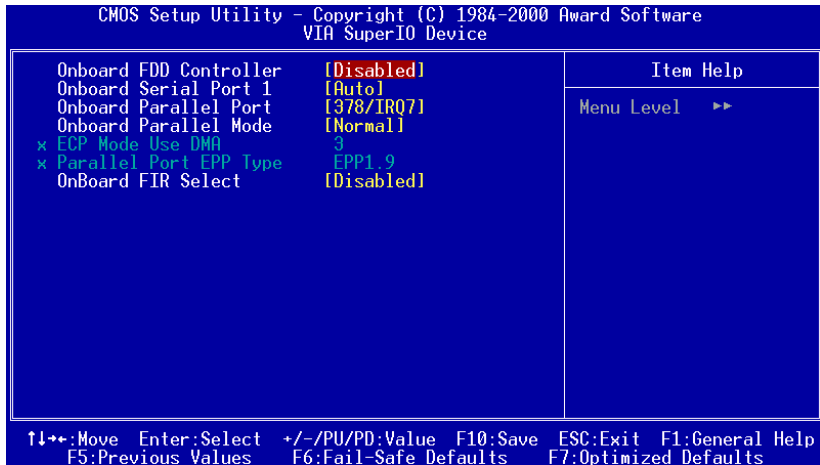

### Onboard FDD Controller

Settings: [Enabled, Disabled]

### Onboard Serial Port 1

Sets the base I/O port address and IRQ for the onboard serial ports A and B. Selecting "Auto" allows the BIOS to automatically determine the correct base I/O port address.

Port	Settings					
1	Disabled	3F8 IRQ4	2F8 IRQ3	3E8 IRQ4	2E8 IRQ3	Auto

### Onboard Parallel Port

This specifies the I/O port address and IRQ of the onboard parallel port.

Settings: [Disabled, 378/IRQ7, 278/IRQ5, 3BC/IRQ7]

### **Onboard Parallel Mode**

Set the parallel port mode. To operate the onboard parallel port as Standard Parallel Port, choose *Normal*. To operate the onboard parallel port in the EPP mode, choose *EPP*. By choosing *ECP*, the onboard parallel port will operate in ECP mode. Choosing *ECP + EPP* will allow the onboard parallel port to support both the ECP and EPP modes simultaneously.

Settings: [Normal, EPP, ECP, ECP + EPP]

### **ECP Mode Use DMA**

ECP (Extended Capabilities Port) has two DMA channels that it can use. The default channel is 3. However, some expansion cards may use channel 3 as well. To solve this conflict, change the ECP channel to 1. Select a DMA channel for the port.

Settings: [1, 3]

### **Parallel Port EPP Type**

EPP (Enhanced Parallel Port) comes in two modes: 1.9 and 1.7. EPP 1.9 is the newer version of the protocol and is backwards compatible with most EPP devices. If your EPP device does not work with the EPP 1.9 setting, try changing the setting to EPP 1.7.

Settings: [EPP 1.9, EPP 1.7]

### **Onboard FIR Select**

Enables the onboard FIR.

Settings: [Enabled, Disabled]

## POWER MANAGEMENT SETUP

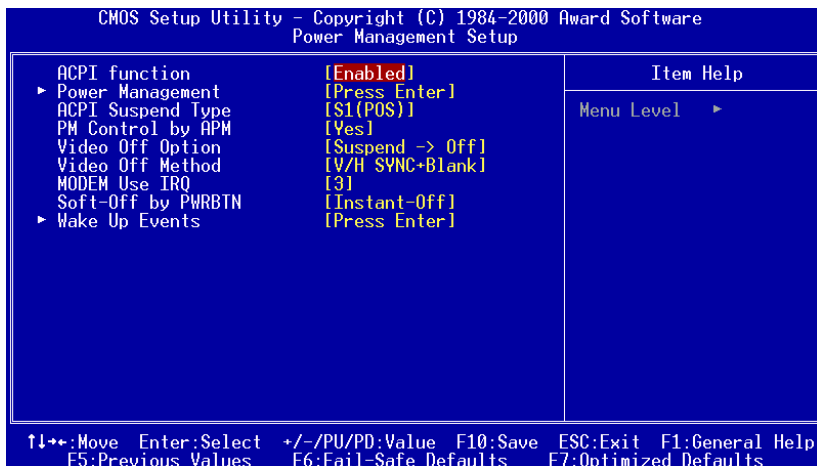

### ACPI Function

Activate the Advanced Configuration and Power Management Interface function.

Settings: [Enabled, Disabled]

### ACPI Suspend Type

Setting	Description
S1(POS)	S1/Power On Suspend (POS) is a low power state. In this state, no system context (CPU or chipset) is lost and hardware maintains all system contexts.
S3(STR)	S3/Suspend To RAM (STR) is a power-down state. In this state, power is supplied only to essential components such as main memory and wakeup-capable devices. The system context is saved to main memory, and context is restored from the memory when a "wakeup" event occurs.
S1 & S3	Depends on the OS to select S1 or S3.

## PM Control by APM

Specify whether the Power Management function is controlled by APM.

Settings: [No, Yes]

## Video Off Option

Select whether or not to turn off the screen when system enters power saving mode, ACPI OS such as Windows XP will override this option.

Setting	Description
Always On	Screen is always on even when system enters power saving mode
Suspend -> Off	Screen is turned off when system enters power saving mode

## Video Off Method

Select the method of turning video off.

Settings: [Blank Screen, V/H SYNC + Blank, DPMS Support]

## Modem Use IRQ

Select the IRQ used by the modem.

Settings: [N/A, 3, 4, 5, 7, 9, 10, 11]

## Soft-Off by PWRBTN

This field configures the power button on the chassis.

Setting	Description
Delay 4 Sec	System is turned off if power button is pressed for more than four seconds
Instant-Off	Power button functions as a normal power-on/-off button

### **AC Loss Auto restart**

The field defines how the system will respond after an AC power loss during system operation.

<b>Setting</b>	<b>Description</b>
Off	Keeps the system in an off state until the power button is pressed
On	Restarts the system when the power is back

## POWER MANAGEMENT

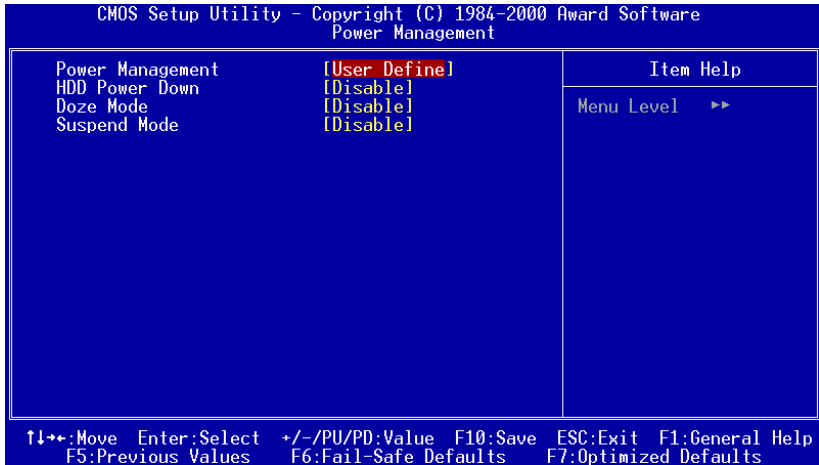

### Power Management

Set the power management function to preset options or user defined parameters. Min Saving – minimal power saving, provides the optimal performance. Max Saving – minimal power consumption.

Settings: [User Define, Min Saving, Max Saving]

### HDD Power Down

Sets the length of time for a period of inactivity before powering down the hard disk.

Settings: [Disabled, 1~15(minutes)]

### Doze Mode

Only available if Power Management function is set to User Define.

Settings: [Disable, 1 Min, 2 Min, 4 Min, 6 Min, 8 Min, 10 Min, 20 Min, 30 Min, 40 Min, 1 Hour]

## **Suspend Mode**

Only available if Power Management function is set to User Define.

Settings: [Disable, 1 Min, 2 Min, 4 Min, 6 Min, 8 Min, 10 Min, 20 Min, 30 Min, 40 Min, 1 Hour]

## WAKE UP EVENTS

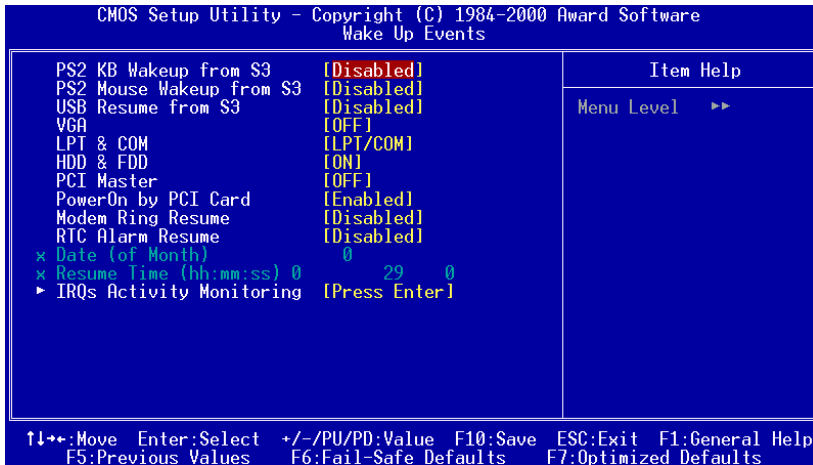

### PS2 KB Wakeup from S3

Enables any keyboard activity to restore the system from the power saving mode to an active state.

Settings: [Disabled, Enabled]

### PS2 Mouse Wakeup from S3

Enables any mouse activity to restore the system from the power saving mode to an active state.

Settings: [Disabled, Enabled]

### USB Resume from S3

Enables activity detected from USB devices to restore the system from a suspended state to an active state.

Settings: [Disabled, Enabled]

### VGA

Enables the power management unit to monitor VGA activities.

Settings: [Off, On]

### **LPT & COM**

Decide whether or not the power management unit should monitor parallel port (LPT) and serial port (COM) activities.

Settings: [None, LPT, COM and LPT / COM]

### **HDD & FDD**

Enables the power management unit to monitor hard disk and floppy disk activities.

Settings: [Off, On]

### **PCI Master**

Enables the power management unit to monitor PCI master activities.

Settings: [Off, On]

### **PowerOn by PCI Card**

Enables activity detected from any PCI card to power up the system or resume from a suspended state. Such PCI cards include LAN, onboard USB ports, etc.

Settings: [Disabled, Enabled]

### **Modem Ring Resume**

Enables a modem Ring-in event to wake up the system from suspend state.

Settings: [Disabled, Enabled]

### **RTC Alarm Resume**

Sets a scheduled time and/or date to automatically power on the system.

Settings: [Disabled, Enabled]

### **Date (of Month)**

The field specifies the date for "RTC Alarm Resume".

### **Resume Time (hh:mm:ss)**

The field specifies the time for "RTC Alarm Resume".

## IRQs ACTIVITIES

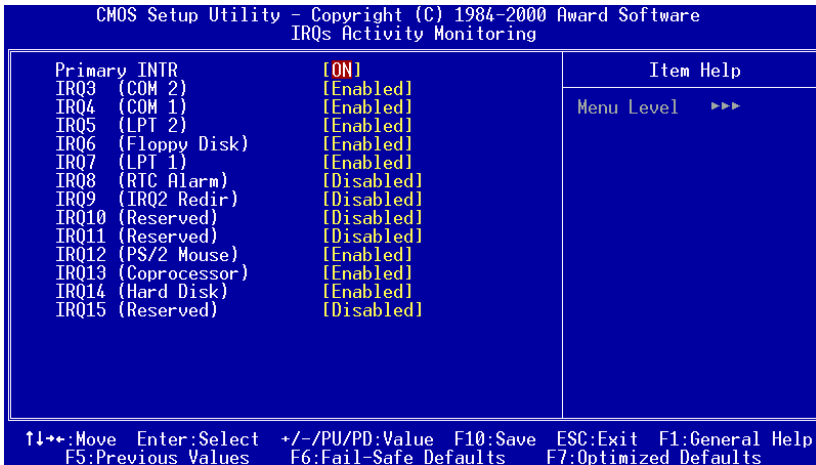

### Primary INTR

Restores the system to an active state if IRQ activity is detected from any of the enabled channels

Settings: [Off, On]

### IRQ3~IRQ15

Enables or disables the monitoring of the specified IRQ line. These fields are only available if "Primary INTR" is on.

Settings: [Enabled, Disabled]

**NOTE:** IRQ (Interrupt Request) lines are system resources allocated to I/O devices. When an I/O device needs to gain attention of the operating system, it signals this by causing an IRQ to occur. After receiving the signal, when the operating system is ready, the system will interrupt itself and perform the service required by the IO device.

## PNP/PCI CONFIGURATIONS

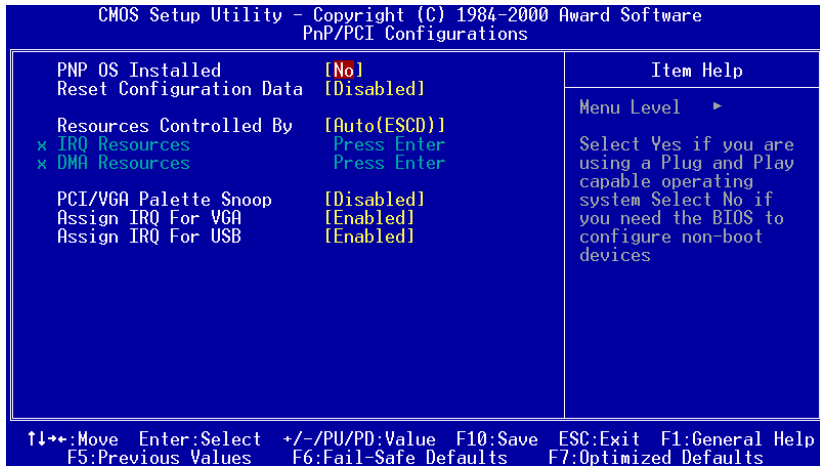

**NOTE:** This section covers some very technical items and it is strongly recommended to leave the default settings as is unless you are an experienced user.

### PNP OS Installed

Setting	Description
Yes	BIOS will only initialize the PnP cards used for booting (VGA, IDE, SCSI). The rest of the cards will be initialized by the PnP operating system.
No	BIOS will initialize all the PnP cards.

### Reset Configuration Data

This field should usually be left "Disabled".

Setting	Description
Enabled	Resets the ESCD (Extended System Configuration Data) after exiting BIOS Setup if a newly installed PCI card or the system configuration prevents the operating system from loading.
Disabled	Default setting.

**Resource Controlled By**

Enables the BIOS to automatically configure all the Plug-and-Play compatible devices.

<b>Setting</b>	<b>Description</b>
Auto(ESCD)	BIOS will automatically assign IRQ, DMA and memory base address fields
Manual	Unlocks "IRQ Resources" for manual configuration

**Assign IRQ For VGA/USB**

Assign IRQ for VGA and USB devices.

Settings: [Disabled, Enabled]

## IRQ RESOURCES

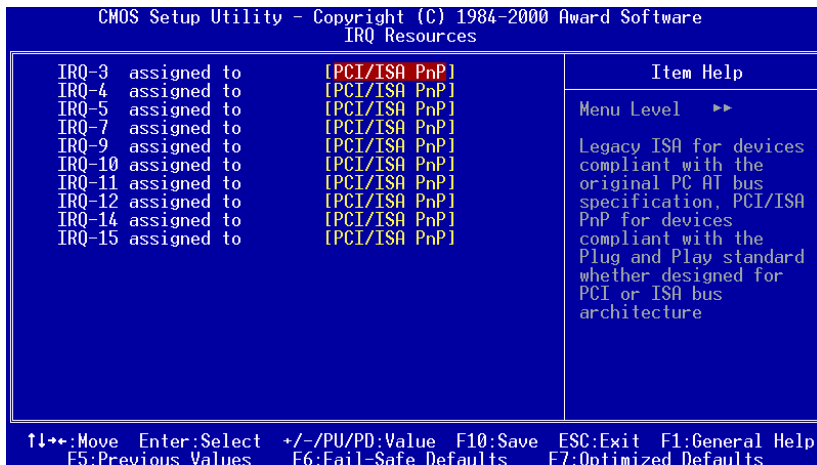

**NOTE:** The items are adjustable only when "Resources Controlled By" is set to "Manual."

IRQ Resources list IRQ 3/4/5/7/9/10/11/12/14/15 for users to set each IRQ a type depending on the type of device using the IRQ.

Setting	Description
PCI Device	For Plug-and-Play compatible devices designed for PCI bus architecture
Reserved	The IRQ will be reserved for other requests

## DMA RESOURCES

CMOS Setup Utility - Copyright (C) 1984-2000 Award Software  
DMA Resources

DMA-0 assigned to	[PCI/ISA PnP]	Item Help
DMA-1 assigned to	[PCI/ISA PnP]	Menu Level ▶▶
DMA-3 assigned to	[PCI/ISA PnP]	Legacy ISA for devices compliant with the original PC AT bus specification, PCI/ISA PnP for devices compliant with the Plug and Play standard whether designed for PCI or ISA bus architecture
DMA-5 assigned to	[PCI/ISA PnP]	
DMA-6 assigned to	[PCI/ISA PnP]	
DMA-7 assigned to	[PCI/ISA PnP]	

↑↓←→:Move Enter:Select +/-/PU/PD:Value F10:Save ESC:Exit F1:General Help  
F5:Previous Values F6:Fail-Safe Defaults F7:Optimized Defaults

Resources list DMA 0/1/3/5/6/7 for users to set each DMA channel type.

Setting	Description
PCI/ISA PnP	For Plug & Play compatible devices designed for PCI bus architecture.
Legacy ISA	For Legacy ISA devices.

## PC HEALTH STATUS

---

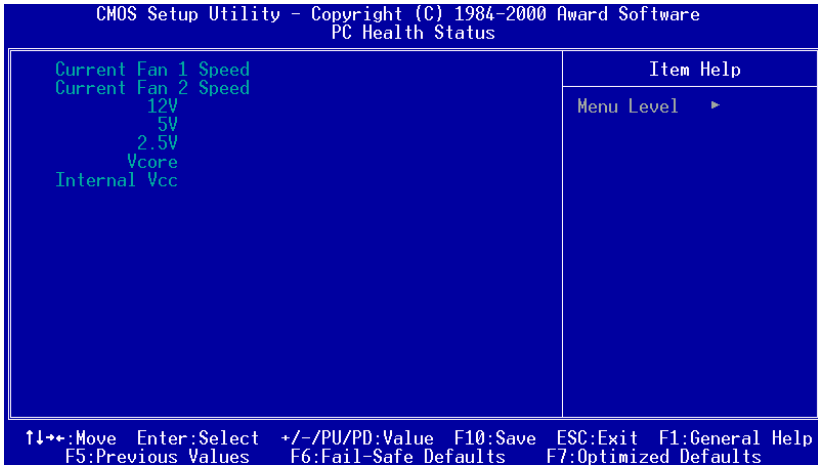

The PC Health Status displays the current status of all of the monitored hardware devices/components such as CPU voltages, temperatures and fan speeds.

## LOAD DEFAULTS

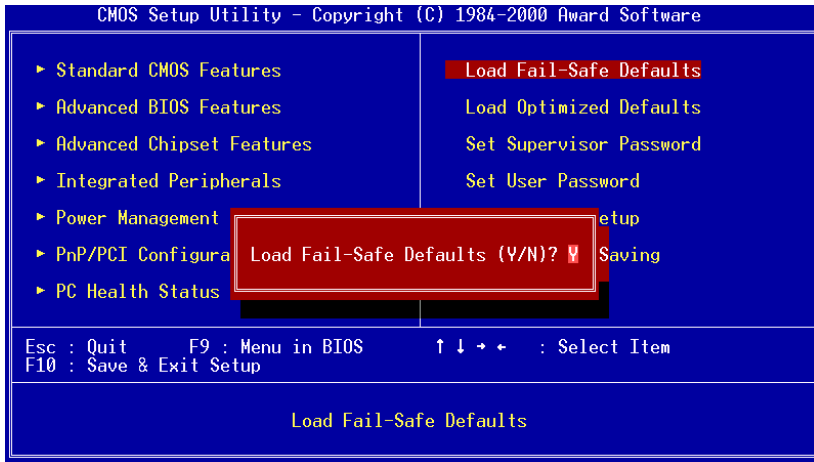

### Load Fail-Safe Defaults

This option is for restoring all the default fail-safe BIOS settings. These values are set by the mainboard manufacturer to provide a stable system with basic performance.

Entering “Y” loads the default fail-safe BIOS values.

### Load Optimized Defaults

This option is for restoring all the default optimized BIOS settings. The default optimized values are set by the mainboard manufacturer to provide a stable system with optimized performance.

Entering “Y” loads the default optimized BIOS values.

## SET SUPERVISOR / USER PASSWORD

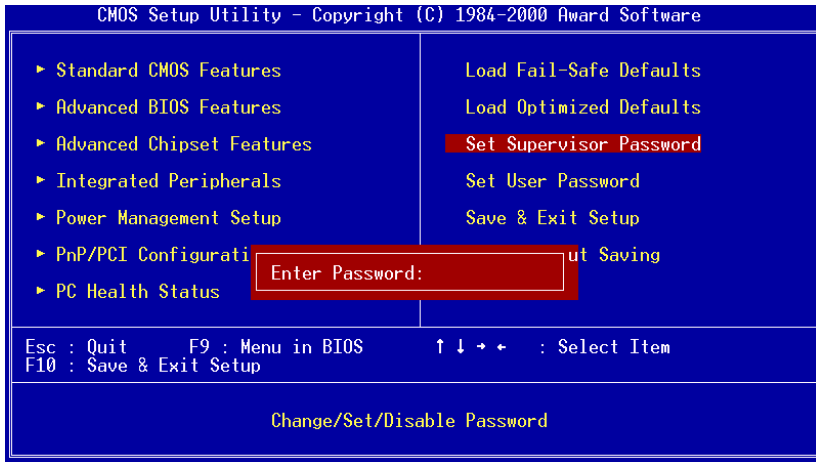

This option is for setting a password for entering BIOS Setup. When a password has been set, a password prompt will be displayed whenever BIOS Setup is run. This prevents an unauthorized person from changing any part of your system configuration.

There are two types of passwords you can set. A supervisor password and a user password. When a supervisor password is used, the BIOS Setup program can be accessed and the BIOS settings can be changed. When a user password is used, the BIOS Setup program can be accessed but the BIOS settings cannot be changed.

To set the password, type the password (up to eight characters in length) and press <Enter>. The password typed now will clear any previously set password from CMOS memory. The new password will need to be reentered to be confirmed. To cancel the process press <Esc>.

To disable the password, press <Enter> when prompted to enter a new password. A message will show up to confirm disabling the password. To cancel the process press <Esc>.

Additionally, when a password is enabled, the BIOS can be set to request the password each time the system is booted. This would prevent unauthorized use of the system. See "Security Option" in the "Advanced BIOS Features" section for more details.

## SAVE & EXIT SETUP

---

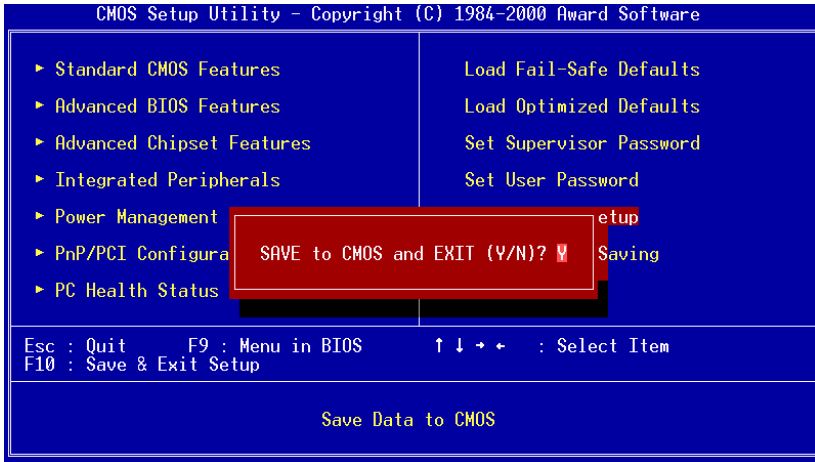

Entering "Y" saves any changes made and exits the program.

Entering "N" will cancel the exit request.

## EXIT WITHOUT SAVING

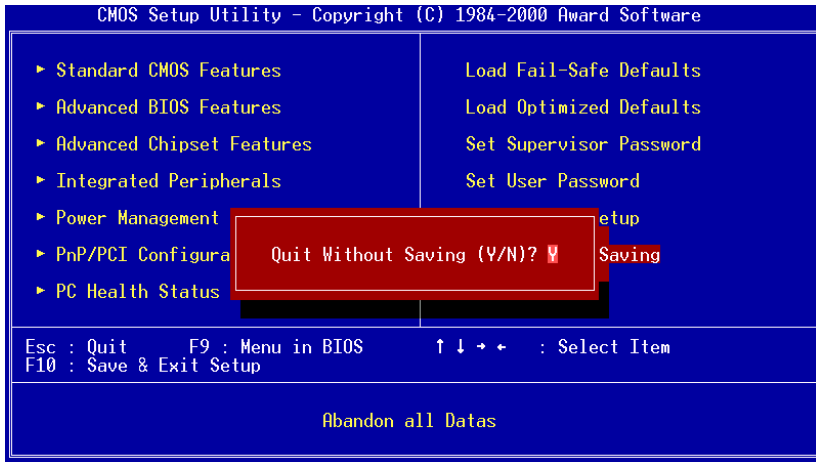

Entering "Y" discards any changes made and exits the program.

Entering "N" will cancel the exit request.

This page left intentionally blank.

---

## CHAPTER 4

# Driver Installation

This chapter gives you brief descriptions of each mainboard driver and application. You must install the VIA chipset drivers first before installing other drivers such as audio or VGA drivers. The applications will only function correctly if the necessary drivers are already installed.

## DRIVER UTILITIES

---

### Getting Started

The mainboard includes a Driver Utilities CD that contains the driver utilities and software for enhancing the performance of the mainboard. If the CD is missing from the retail box, please contact the local dealer for the CD.

**Note:** The driver utilities and software are updated from time to time. The latest updated versions are available at <http://www.viaembedded.com/>

## Running the Driver Utilities CD

To start using the CD, insert the CD into the CD-ROM or DVD-ROM drive. The CD should run automatically after closing the CD-ROM or DVD-ROM drive. The driver utilities and software menu screen should then appear on the screen. If the CD does not run automatically, click on the "Start" button and select "Run..." Then type: "D:\Setup.exe".

**NOTE:** D: might not be the drive letter of the CD-ROM/DVD-ROM in your system.

## CD CONTENT

---

- ☒ **VIA 4in1 Drivers:** Contains VIA ATAPI Vendor Support Driver (enables the performance enhancing bus mastering functions on ATA-capable Hard Disk Drives and ensures IDE device compatibility), AGP VxD Driver (provides service routines to your VGA driver and interface directly to hardware, providing fast graphical access), IRQ Routing Miniport Driver (sets the system's PCI IRQ routing sequence) and VIA INF Driver (enables the VIA Power Management function).
- ☒ **VIA Graphics Driver:** Enhances the onboard VIA graphic chip.
- ☒ **VIA Audio Driver:** Enhances the onboard VIA audio chip.
- ☒ **VIA USB 1.1 Driver:** Enhances VIA USB 1.1 ports.
- ☒ **VIA LAN Driver:** Enhances the onboard VIA LAN chip.
- ☒ **VIA FIR Driver:** Support for FIR.